

COLONIAL

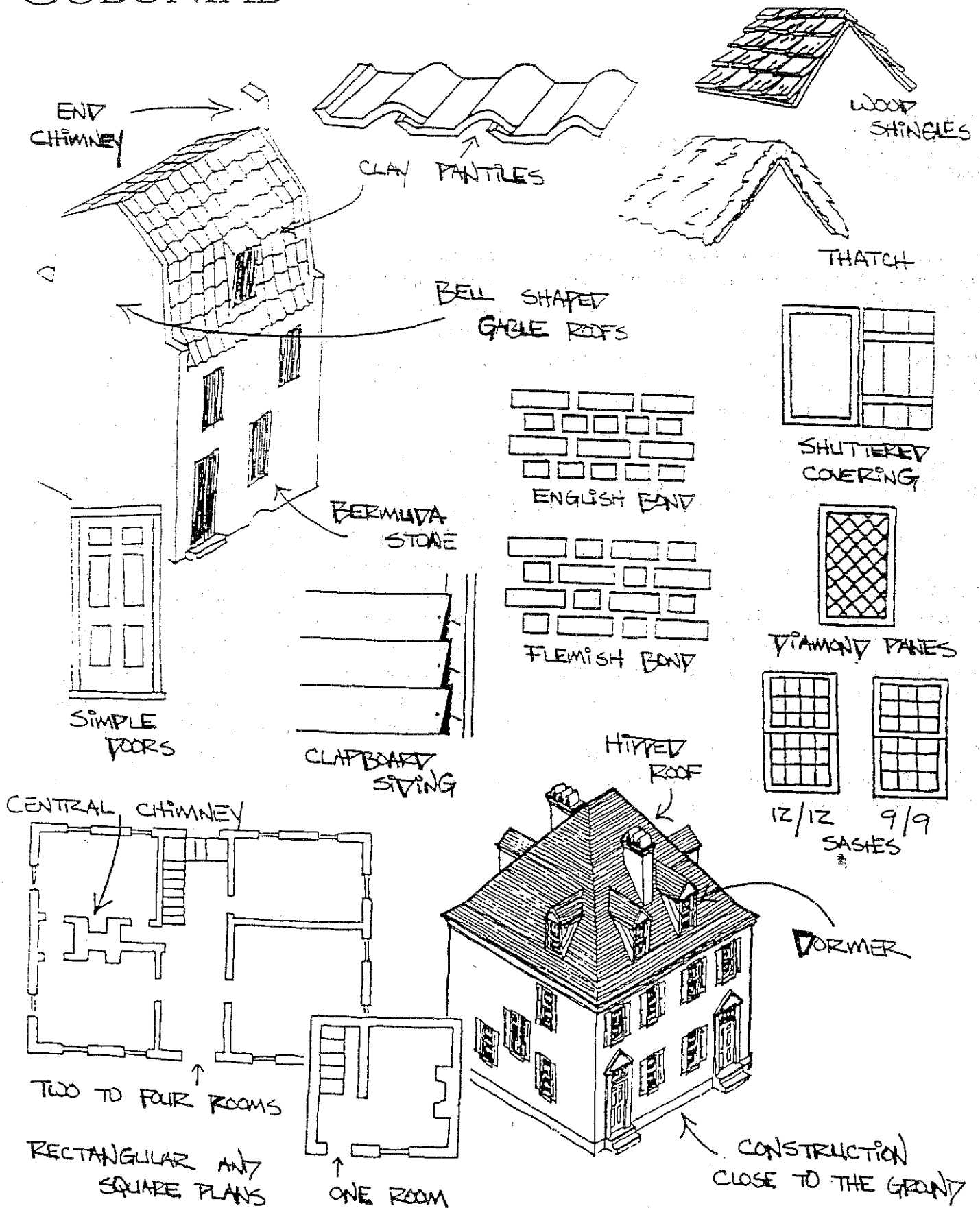

GEORGIAN

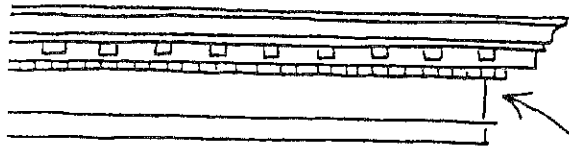

DECORATIVE CORNICE

CENTRAL HALL

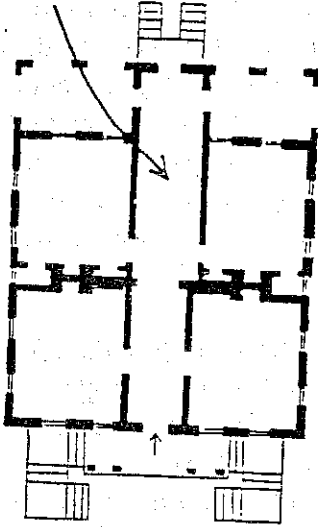

SYMMETRICAL FLOORPLANS AND FACADES

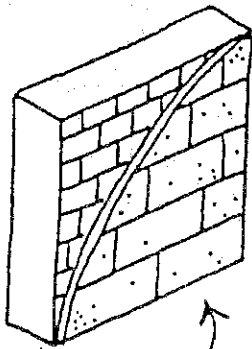

SCORED STUCCO OVER BRICK

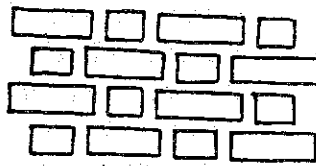

FLEMISH BOND

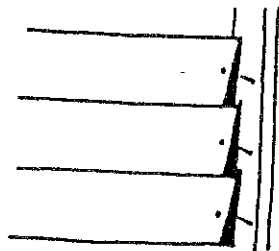

CLAPBOARD SIDING

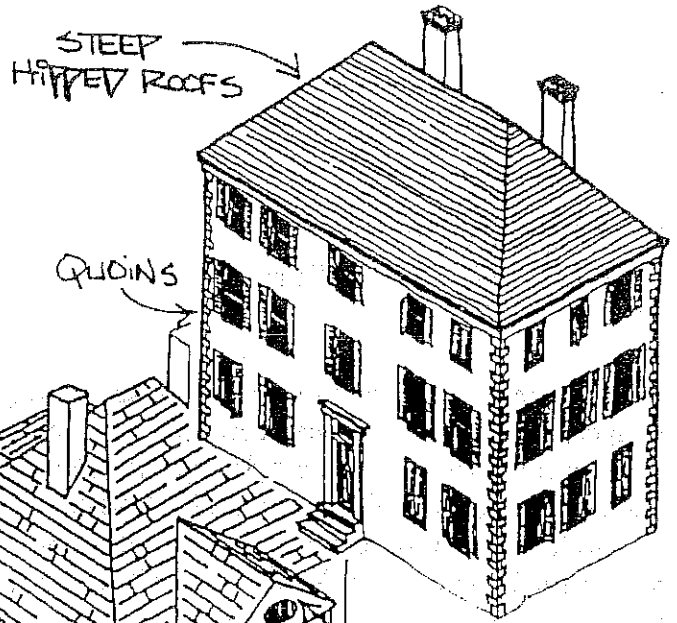

STEEP HIPPED ROOFS

QUOINS

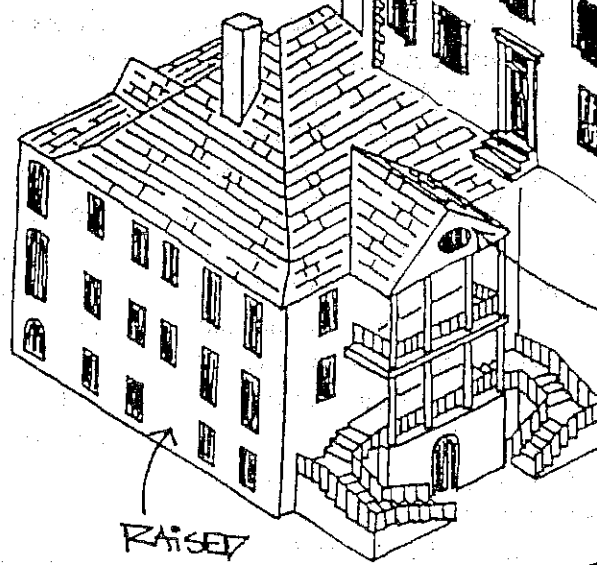

RAISED BASEMENT

PROJECTING PEDIMENTS FOR CENTRAL PORTICO

PEDIMENTED DOORS

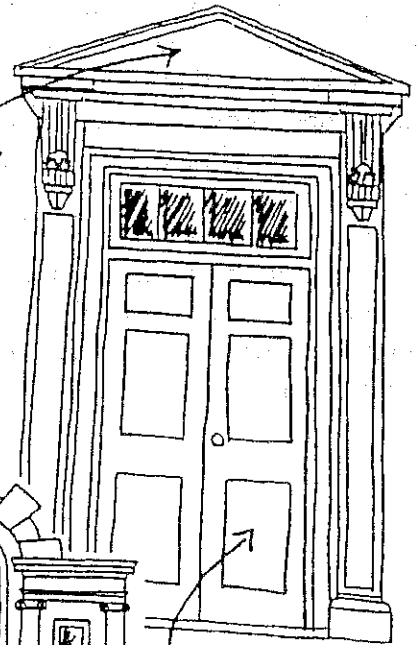

DOUBLE, PANELED DOORS

QUOINS

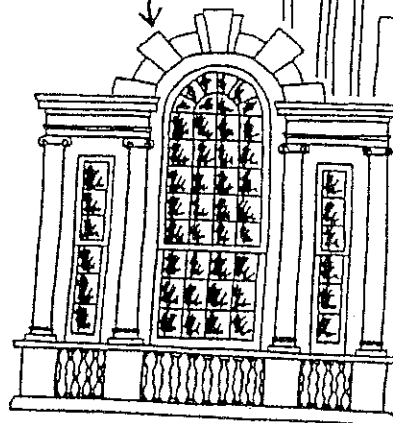

TRI-PART WINDOWS

FEDERAL

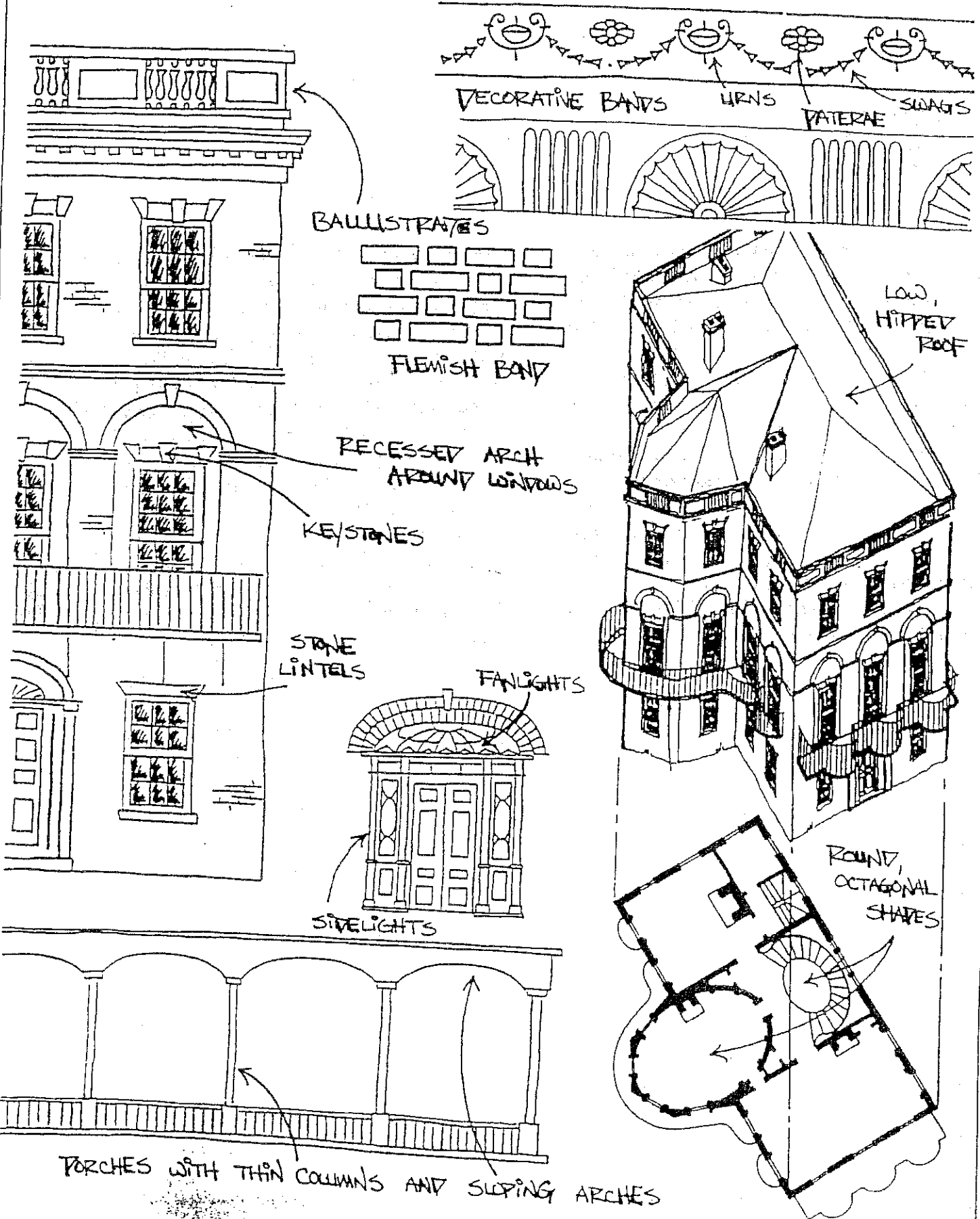

CLASSICAL REVIVAL

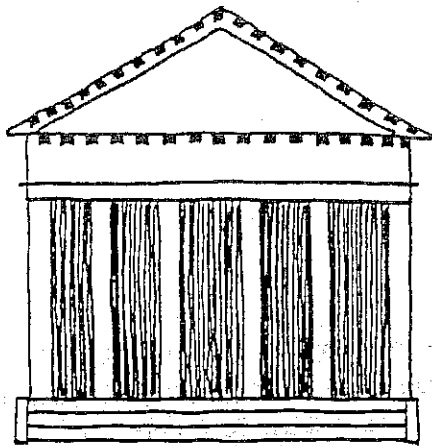

TEMPLE FRONT

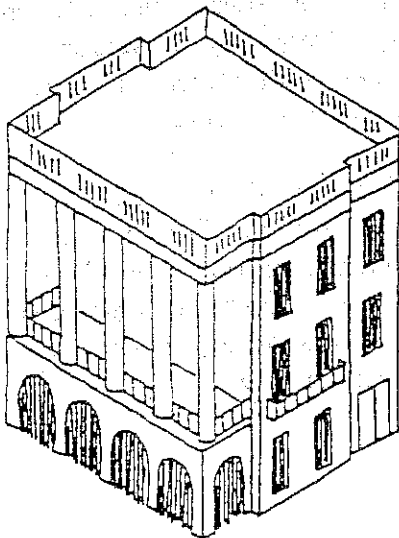

SIDE PORCHES

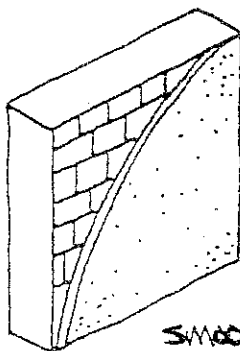

SMOOTH STUCCO OVER BRICK

COLUMNS

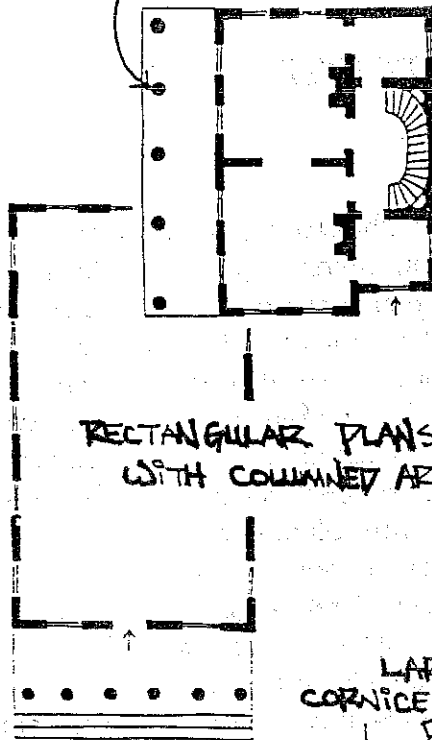

RECTANGULAR PLANS WITH COLUMNED AREAS

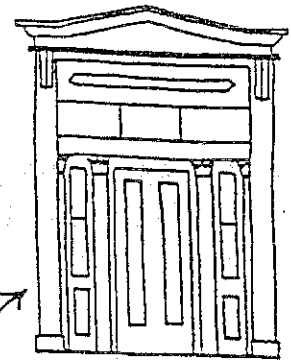

OPENINGS WITH LARGE TRIM

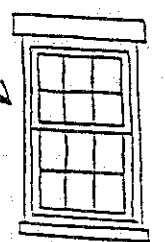

6/6 SASH

LARGE CORNICES

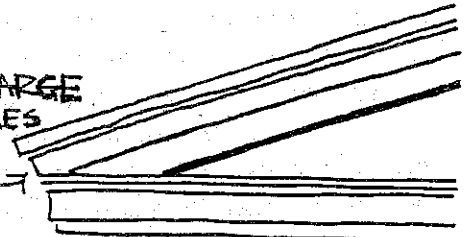

CLASSICAL DETAILING

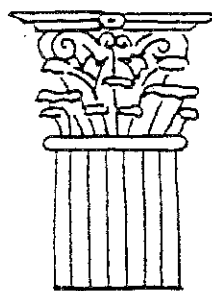

CORINTHIAN

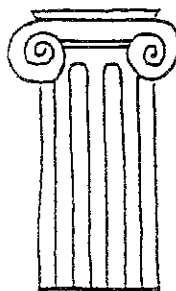

IONIC

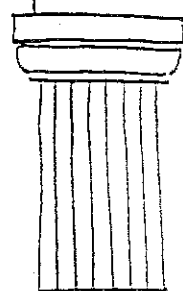

DORIC

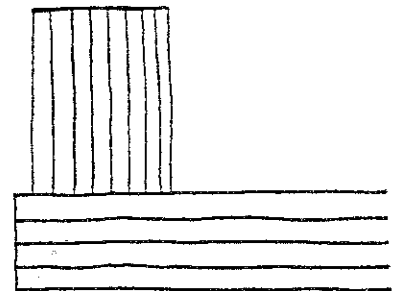
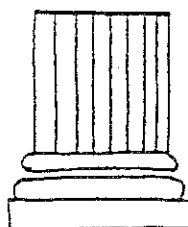
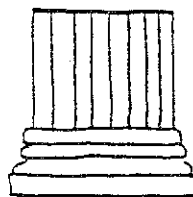

GOTHIC REVIVAL

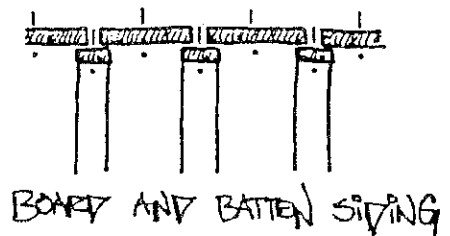
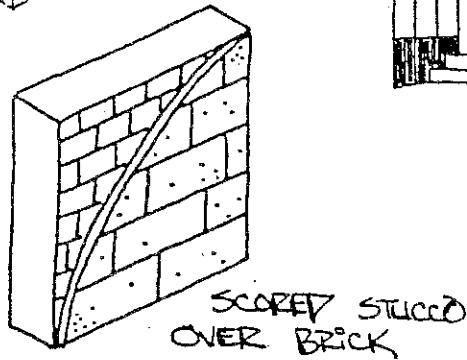
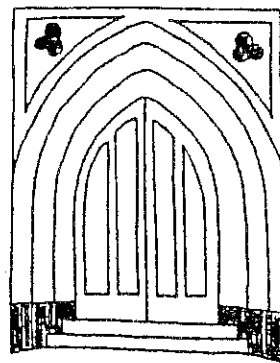
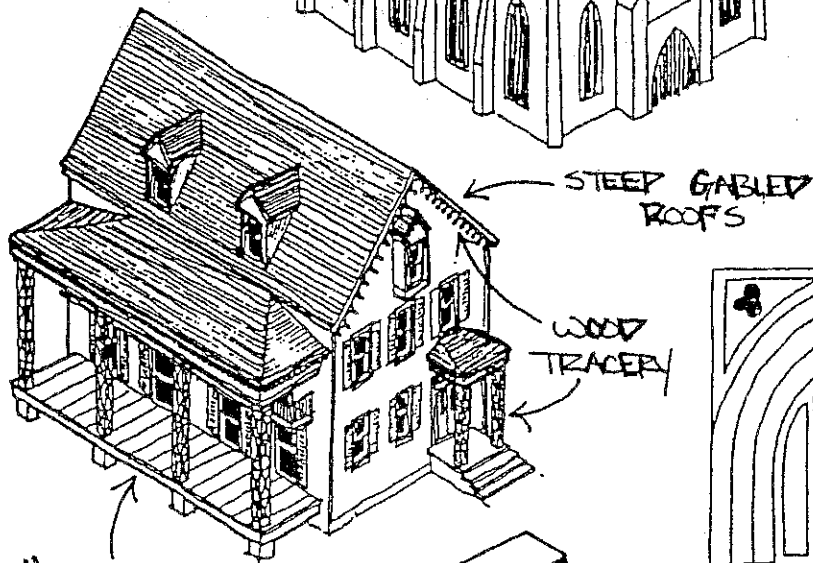
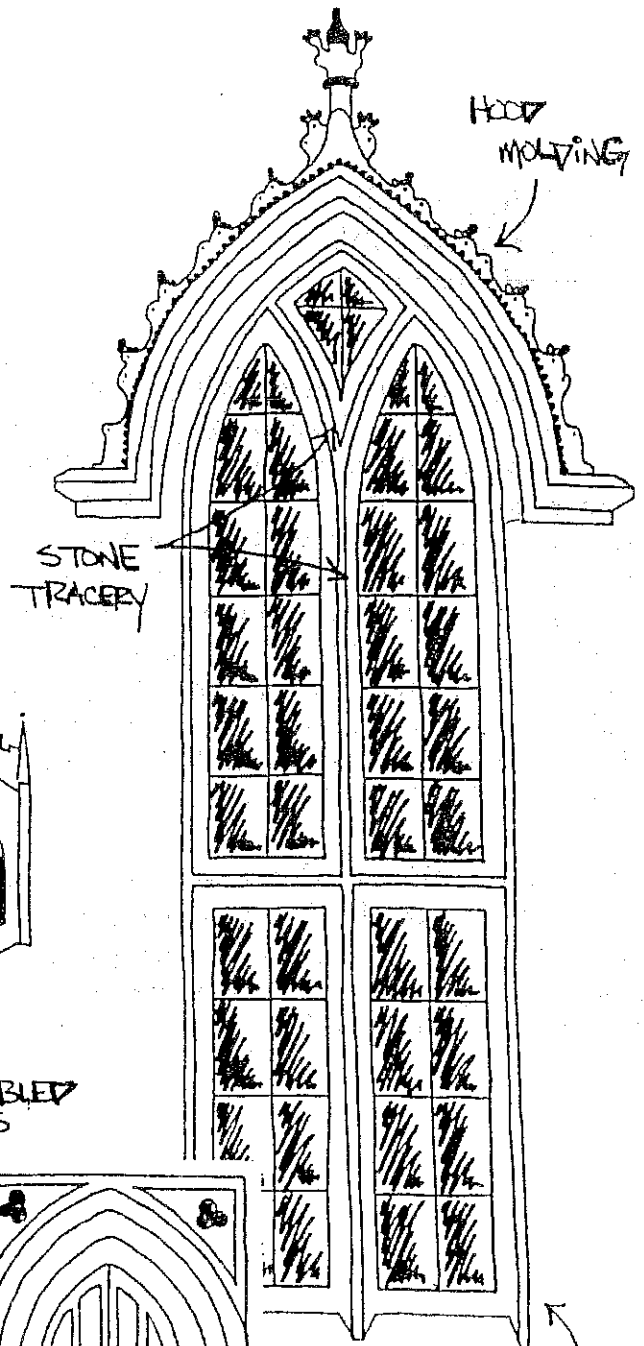
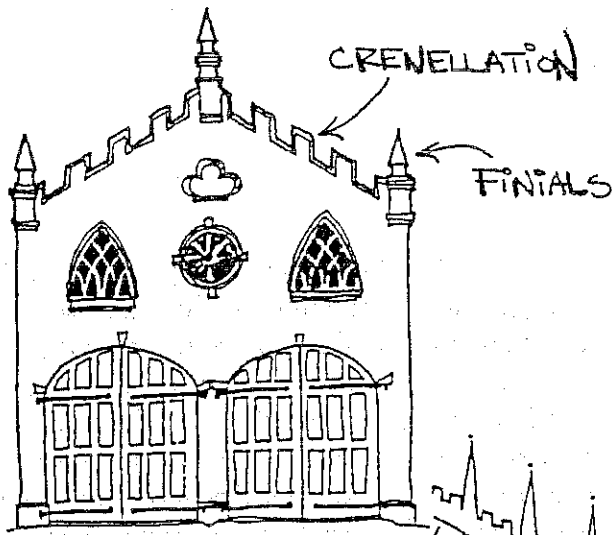

ITALIANATE

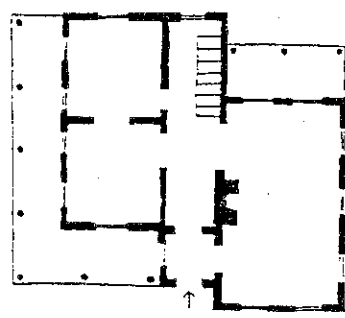
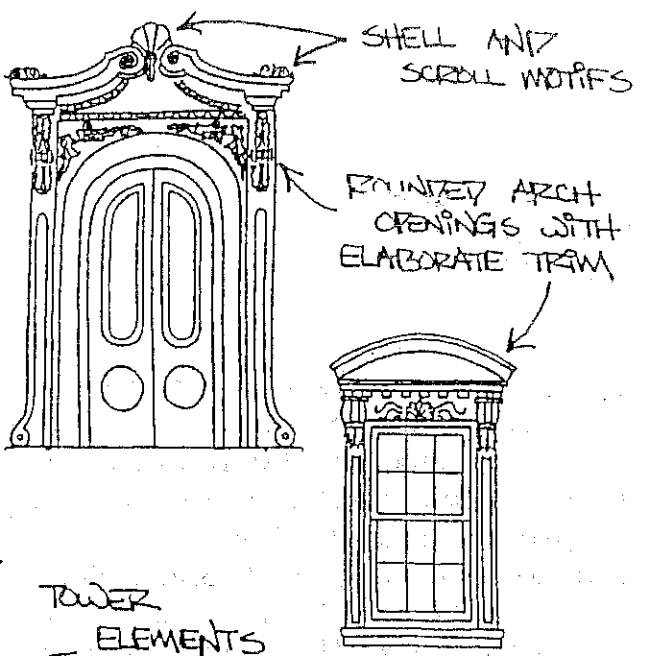
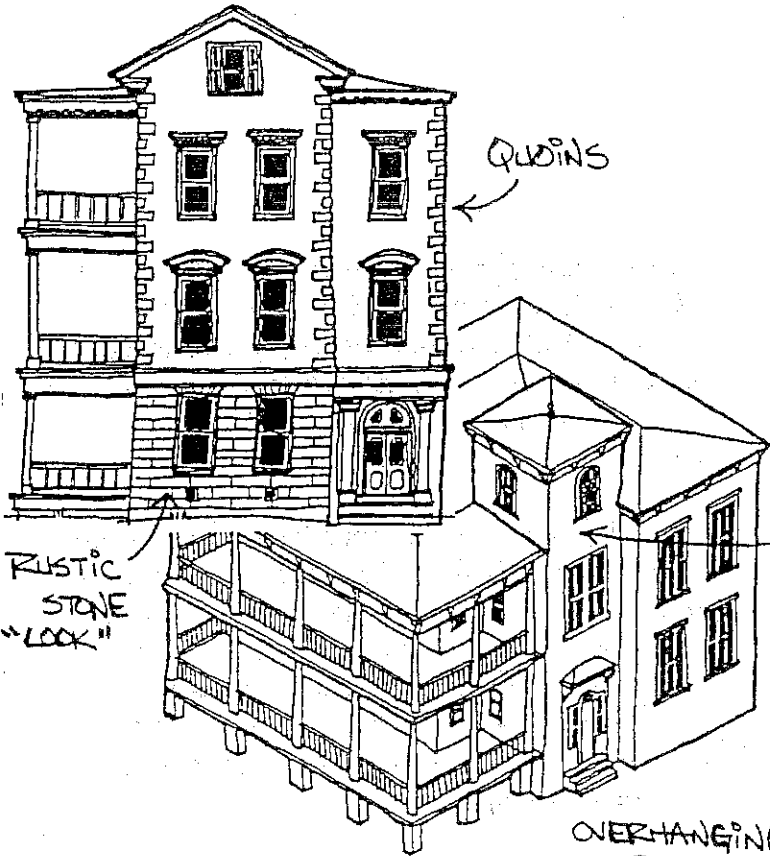

ASYMMETRICAL PLANS

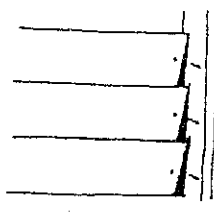

CLAPBOARD SIDING

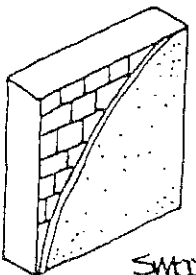

SMOOTH STUCCO

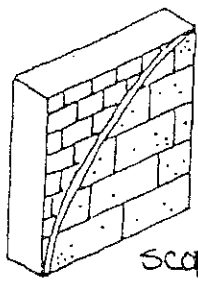

SCORED STUCCO

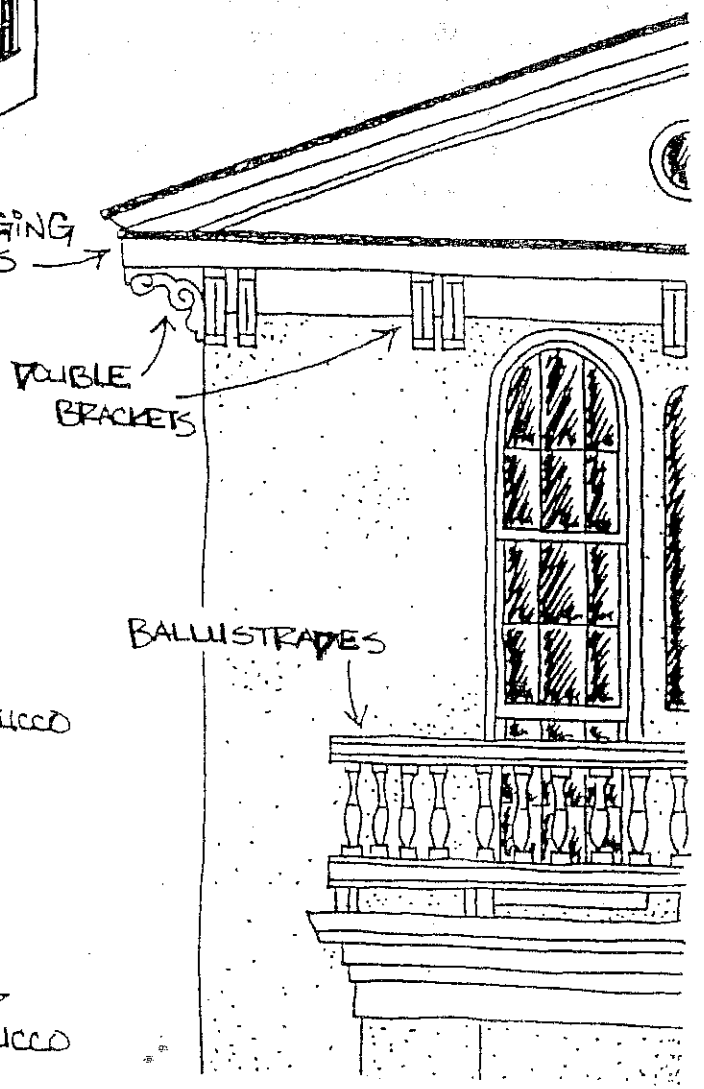

VICTORIAN

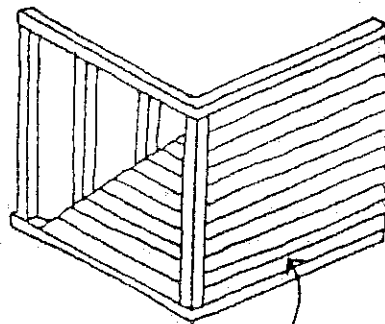
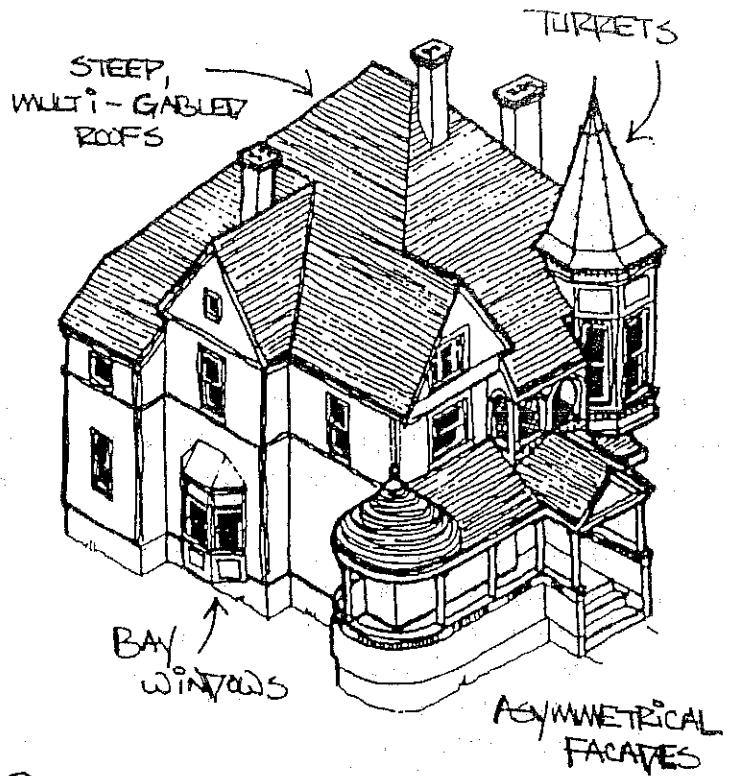
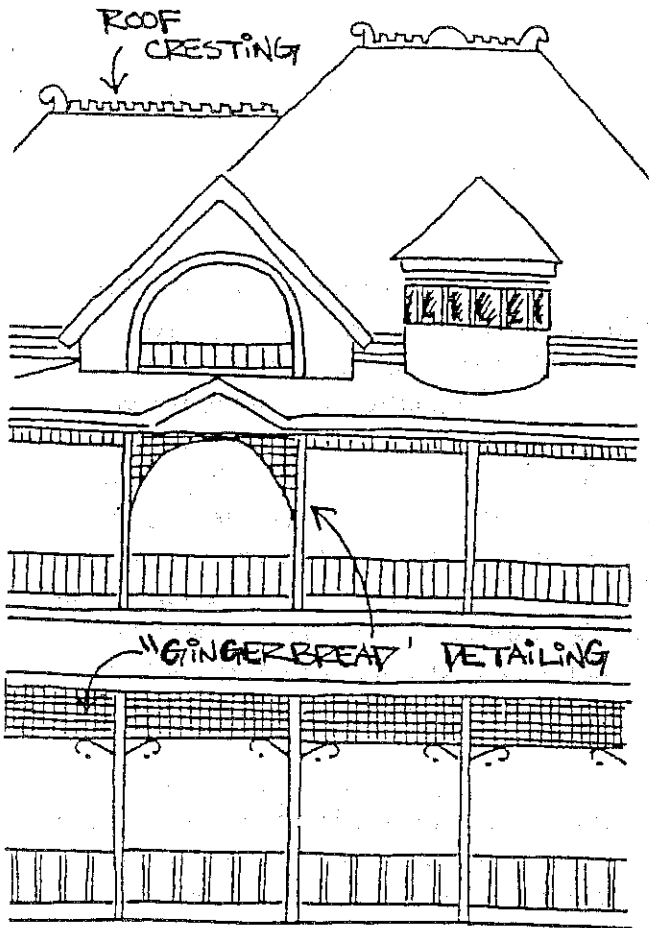

BALCONY FRAME CONSTRUCTION

CLAPBOARD SIDING

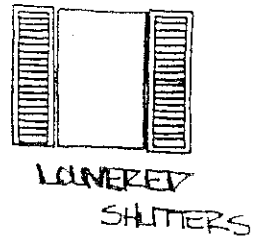
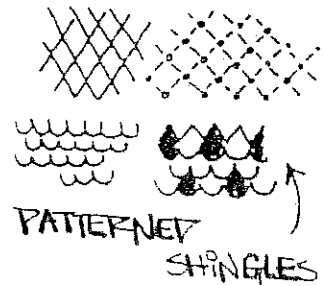

SMALL TAPEY BORDERS IN OPENINGS

